

# Installation Instructions

Stainless Steel Sliding Exposed  
Duplex System [ST.1007.DU]

1901 Tigertail Blvd.  
Dania Beach FL, 33004  
Phone: 954.924.6137  
Fax: 954.924.6138



It is the sole responsibility of the purchaser to provide adequate wall/ceiling support to accommodate the weight of such rail system!

For ceiling or glass mounts substitute Steps 1-4 with appropriate Installation Instructions. Consider Step 3 (Installation of stoppers to rail)

Please refer to the Frequently Asked Questions page included in this package before beginning installation.

## You Will Need:

Spirit Level  
Measuring Tape  
Power Drill  
8mm [5/16"]/10mm [3/8"]drill bit  
Phillips Screwdriver

Metric Allen Key Set  
Plastic Wedge or Wood Shims  
BARTELS provided general specification sheet(s)  
BARTELS Measurement Forms specific to current project  
Combination Wrench size 10mm [3/8"]



**Step 1:**

**Drill first hole**  
Locate and drill first hole based on BARTELS provided general specification sheets and or project specific Measurement Forms.

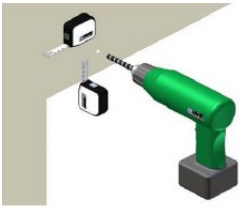

NOTE: Solid backing is required!

**Step 6:**

**Attach wheel to panel**  
Safely secure panel on a flat surface. Prepare the top of panel according to BARTELS provided general specification sheets. Remove anti-jump from wheel assembly. Secure the wheel assembly to the panel with machine screws provided. Do not re-attach anti-jump. Insure all screws are tight!

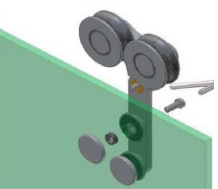

**Step 2:**

**Drill remaining mounts**  
"Loosely" screw on wall mounts. See step 3. Align rail horizontally using the spirit level. Use rail as drilling jig for wall drillings and pre-drill further fastening holes with 8mm drill bit. Then drill holes for plastic anchors with 10mm drill bit.

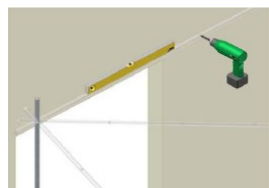

**Step 7:**

**Hanging the panel**  
Gently hang assembled panel onto rail. Place plastic wedges or wood shims beneath the panel to secure and insure a 7mm (1/4") undercut. Navigate panel onto floor guide. Ensure the stops are secure and remove shims.

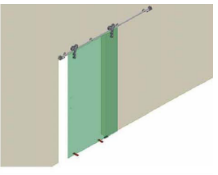

**Step 3:**

**Install stoppers to rail**  
Fasten door stopper on left and right end of rail to prevent the sliding door from sliding off the rail during installation.

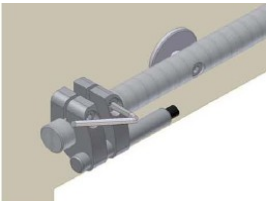

NOTE: Double door application requires center stops.

**Step 8:**

**Re-attach Anti-Jump**  
Re-attach anti-jump to wheel assembly. (Using combination wrench size 10mm)

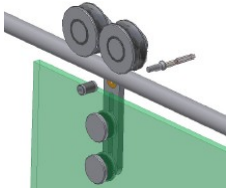

Warning: Do Not leave any space between the anti-jump and the rail.

**Step 4:**

**Mount rail to wall**  
Fasten rail on wall using enclosed fastening materials.



**Step 9:**

**Examine function ability**  
Test that the door is sliding properly. Make any necessary adjustments to stoppers. Now attach the handles.

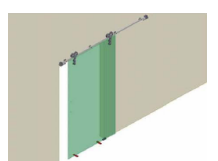

**Step 5:**

**Attach floor guide**  
Fasten floor guide on floor using enclosed fastening materials and according to BARTELS provided general specification sheets. Door leaf should run parallel to wall at specific distance from wall or baseboard.

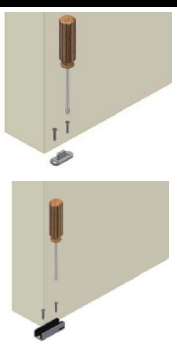

**Step 10:**

**Tighten Screws**  
Be sure to go back to all screws and tighten.



Duplex System is suitable for but not limited to glass and wood panels, instructions may be used for installation of all Duplex applications

For technical assistance please contact BARTELS Monday-Friday 9:00am-5:00pm Eastern Standard Time

It is the sole responsibility of the purchaser to provide adequate wall support to accommodate the weight of this rail system!

Solid backing throughout the entire length of rail is recommended!

### Wall Mount Assembly:

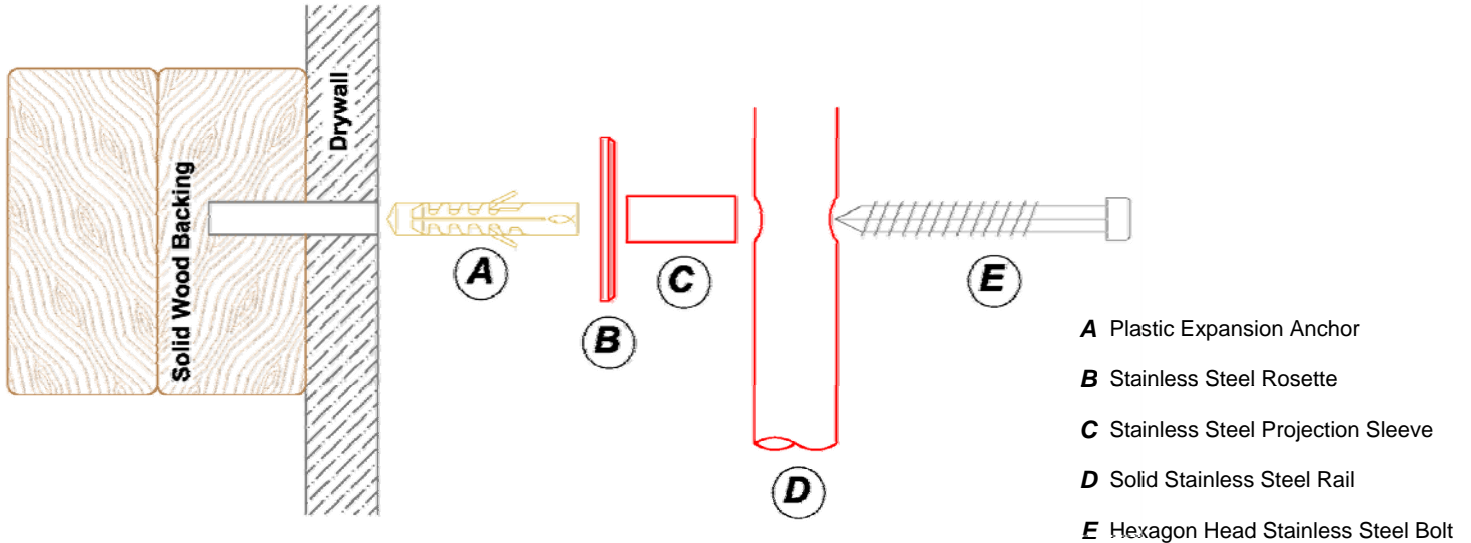

### Stainless Steel Care and Advice:

The alloy stainless steel contains chrome and nickel which seems to make its surface resistant to bacterial depositing and is extremely easy-care. In case our product shows signs of rust on the surface, this is to be rust which has been deposited by the environment. This problem can especially arise in industrial estates or nearby the coast. In that case, the rust can be rubbed away but we regret that goods cannot be replaced after purchase.



**Do not use harsh chemicals on or near this hardware.**

### Frequently Asked Questions:

**Question:** I don't think my wall mounts project far enough from the wall

*Answer:* Panel, baseboard and or casing thickness determine the components supplied, verify all field dimensions with the dimensions provided. For replacements please call 1-866-331-4147

**Question:** What type of backing do you suggest?

*Answer:* A minimum of 2x4 positioned throughout the full length of the rail is suggested. It is best to consult an architect or engineer familiar with the project and or structure of the wall.

**Question:** Can I cut the rail on site?

*Answer:* Rails are pre-drilled, it is possible to cut through the solid 1" diameter rail if necessary. Consider cutting equally from each end to maintain equal distances between mounts.

**Question:** How do I prepare my panel for the hardware?

*Answer:* Follow product specifications detailed on the downloadable specification sheets at [www.stainlessdoorhardware.com](http://www.stainlessdoorhardware.com) for questions call 1-866-331-4147

**Question:** How do I order additional or replacement parts?

*Answer:* For replacement parts call 1-866-331-4147 or e-mail [sales@stainlessdoorhardware.com](mailto:sales@stainlessdoorhardware.com) reference original order number if available.

**Question:** Does this hardware have a warranty?

*Answer:* Yes. A limited 2 year warranty is available to the purchaser, please e-mail [sales@stainlessdoorhardware.com](mailto:sales@stainlessdoorhardware.com) to request a copy.

**Question:** What is the best cleaning method?

*Answer:* Regular cleaning is advised as the components rely on a smooth surface for maximum performance, gently wipe stainless steel surfaces with a damp soft cloth. Purchase Stainless steel cleaners at [www.stainlessdoorhardware.com](http://www.stainlessdoorhardware.com)